

Scale 1:2

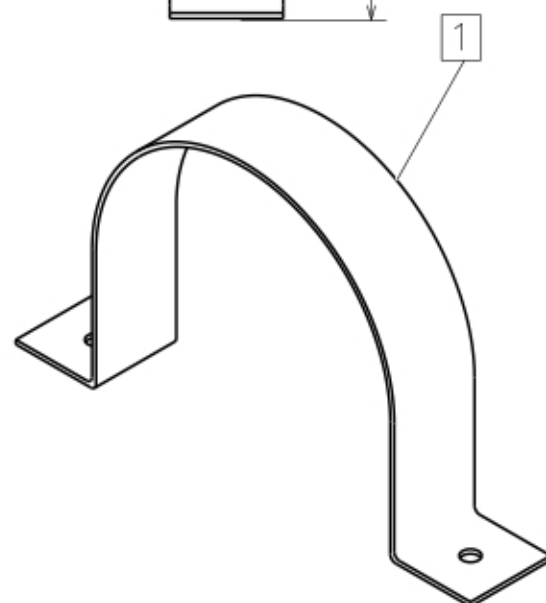
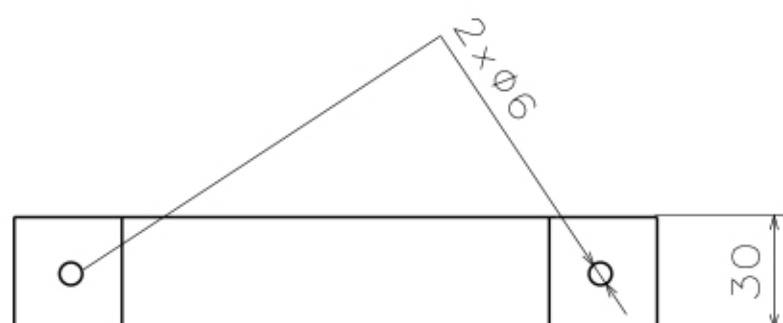
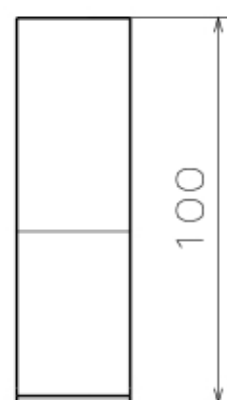
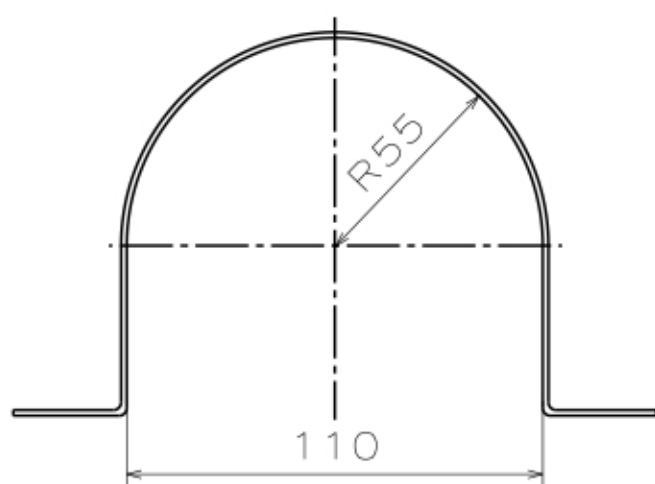

Spetsifikatsioon

Pos	Nimetus	Kogus	Kaal,kg	Materjal
1	Kuumtsingitud leht 1,5 1,5x30x315	1	0,113	Z275
		Kokku	0,113	

Toode on kasutamiseks korrosioonikategooriate C1 ja C2 tingimustes EVS-EN ISO 12944-2:2000

Nimetus

Klamber

Kood

UKSL1010

LEKU
METALL